



OIL & GAS

Energy Distribution Solutions and Lighting Systems



OIL & GAS





CONTENTS

►► Oil & Gas

Company Profile	2-3
Medium Voltage Busbar Distribution Systems	4-5
Busbar Power Distribution Systems	6-7
Cable Tray Systems	8-13
Lighting Systems	14
Sample References	15-16
References List	17



EAE Group in numbers;

280.000m²
closed manufacturing area

1973
year of foundation

5
manufacturing plants

100+
countries of export

Founded in 1973, EAE Elektrik A.S. being the parent company of EAE Group is a worldwide manufacturer of electrical products.

Founded : in 1973
Closed Manufacturing Area : 280.000m²
Range of Products : Busbar Power Distribution Systems
Lighting Busbar Systems
Cable Tray Systems
Underfloor Trunking
Trolley Busbar Systems

Companies : EAE Elektrik
EAE Aydınlatma
EAE Elektroteknik
EAE Teknoloji
EAE Makina

Number of Plants : 5

"Lean Production" and "Innovative and Customer Driven Product Development" approaches are the key values utilized in designing and manufacturing the product families in compliance with ISO 9001, ISO 14001, OHSAS 18001 and ISO 27001.

EAE Elektrik A.S. busbar products are certified by KEMA/DEKRA (Holland), KEMA - KEUR, UL classified laboratories as per IEC 61439-1/6 standards.

Power Generation
Industry

Oil&Gas
Industry

Petrochemical
Industry

Oil&Gas Sector

Supervision Services

Experienced EAE engineers are available for measurement, installation and testing services on-site.



Design & Software Support

Special software for practical and rapid project design providing precise material lists.

EAE products are available in Revit, AVEVA and Smartplant 3D.



Short Response & Delivery Time

Extensive manufacturing capacity to provide delivery in 3-4 weeks time with ex Works terms.

Emergency manufacturing team can produce in 48 hours any immediate requirement due to site hold items or damaged items during installation.



Design & Software Support

Comprehensive technical product consultancy for the tailored customer solution and technical design services free of charge.

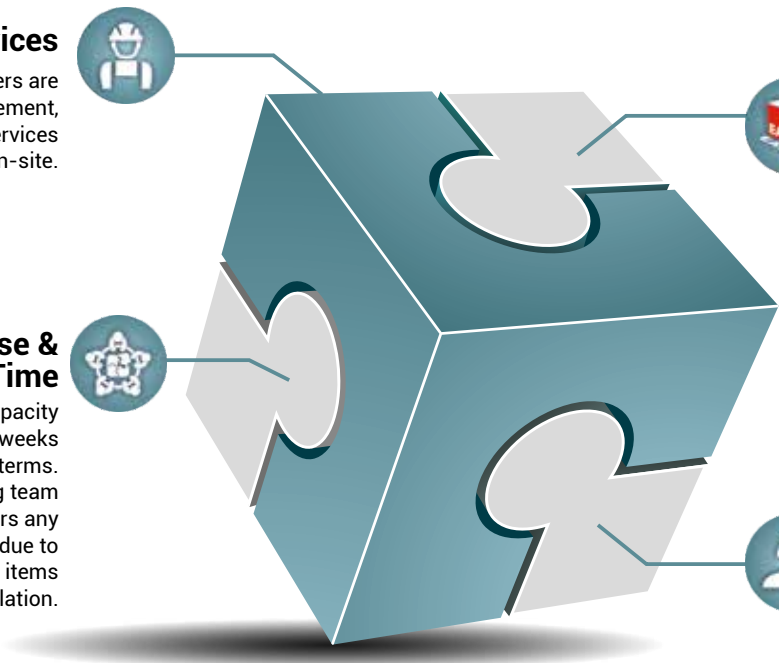

Certificates



Busbar Distribution System 950...2750 A for 12kV

The body of the E-Line MV busbar is formed using DURACOMP, a composite material of epoxy resin and pure silicon which gives protection against arduous environments and high impact with high conductivity copper conductors.

ELINE
MV
BUSBAR



Applications:



Power Plants



Substations

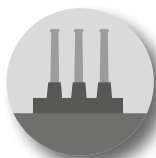

Industrial Manufacturing



Civil Engineering Projects



Offshore

Table of Busbar Cross Section Sizes

MVC - Cu Conductor	Rated Current (A)	950	1150	1350	1650	2250	2750
	Busbar Code	09	11	13	16	22	27
A	mm	90	105	120	145	190	250
B	mm	192	192	192	247	297	347

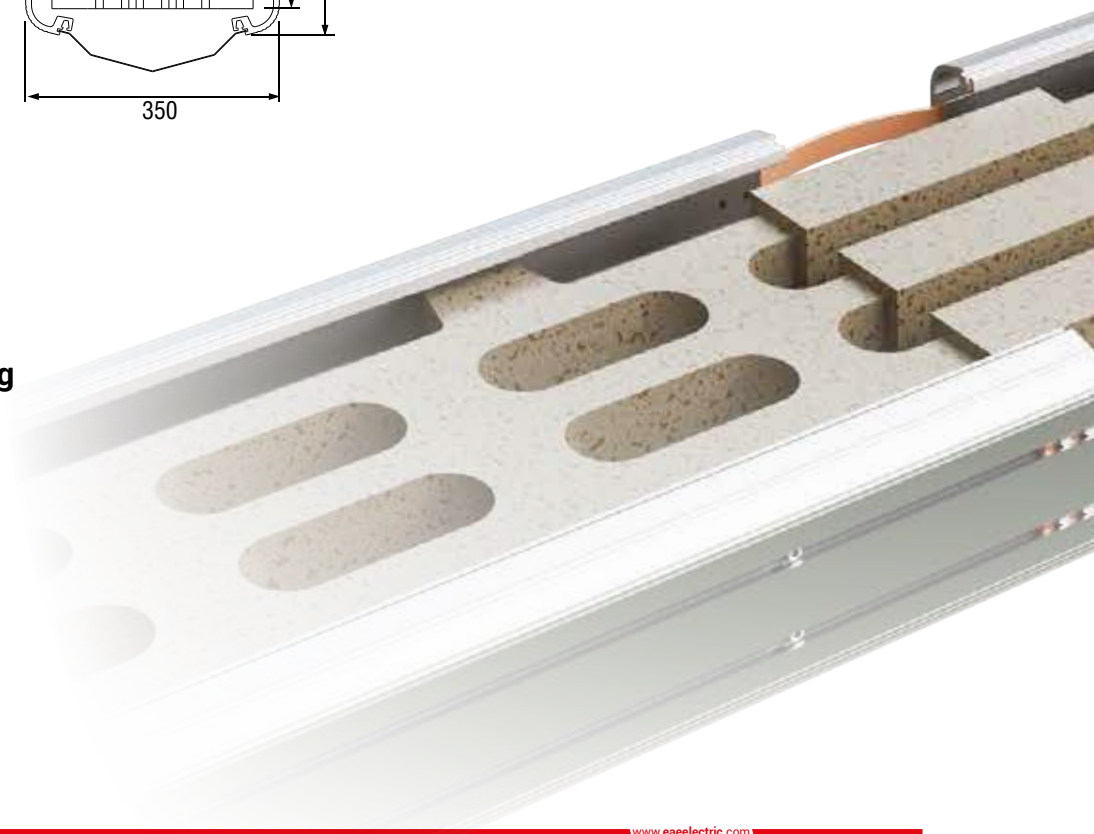
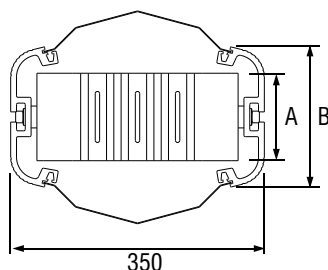

Busbar Distribution System 1500...5700 A for 24kV

The body of the E-Line MV busbar is formed using DURACOMP, a composite material of epoxy resin and pure silicon which gives protection against arduous environments and high impact with high conductivity copper conductors.

ELINE
MV
BUSBAR

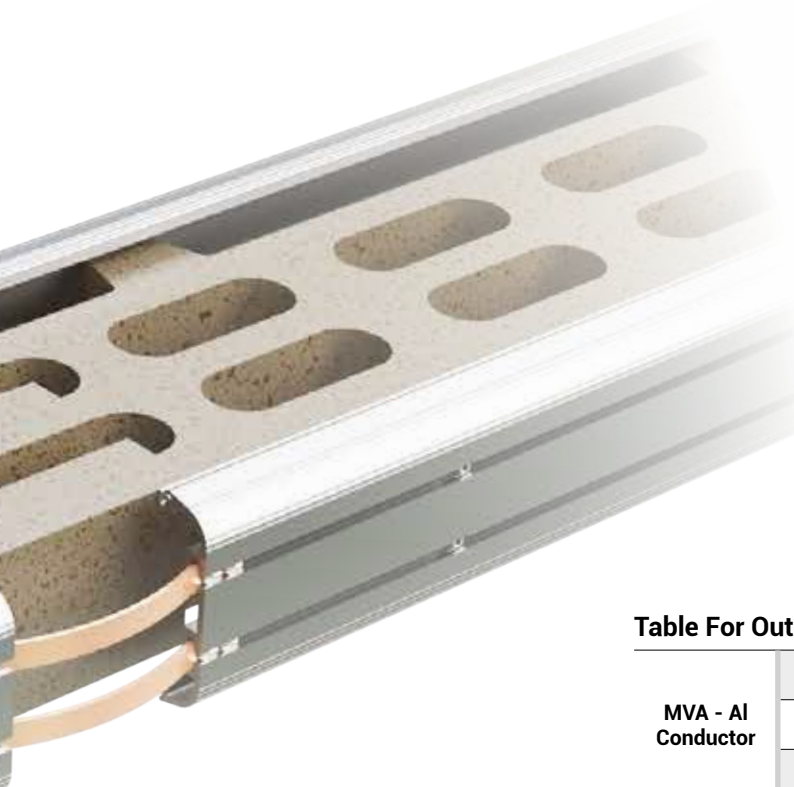

- According to international standards
- Insulated with Cast Resin
- High mechanical strength
- Special Terminal Elements solution
- Chemical Resistance
- High degree of fire withstand
- Indoor & Outdoor Applications
- Ambient temperature -60 + 55
- High degree protection (IP68)
- Low power losses
- High resistance to ultraviolet, chemicals and aggressive environments

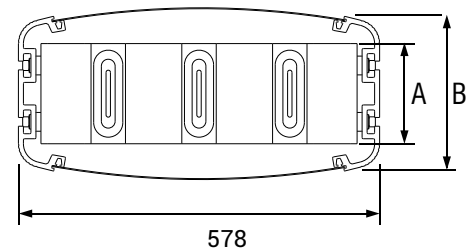

Table For Outer Dimension of Busbars

MVA - Al Conductor	Conductor Cross Section		7X75	12X100	12X150	12X200	-
	Rated Current (A)		1500	2000	2500	3000	-
	Busbar Code		15	20	25	30	-
MVC - Cu Conductor	Conductor Cross Section	7X70	7X75	12X100	12X150	12X200	15X200
	Rated Current (A)	1800	2100	3200	4000	5000	5700
	Busbar Code	18	21	32	40	50	57
A	mm	160	160	160	210	260	260
B	mm	247	247	247	297	347	347

Compact Busbar Distribution System 400...7500 A

The EAE E-Line KX Series compact busbar system is designed and produced using the latest technology for high power distribution with ratings from 400A to 7500A with high conductivity copper and aluminum conductors.

ELINE
KX
BUSBAR

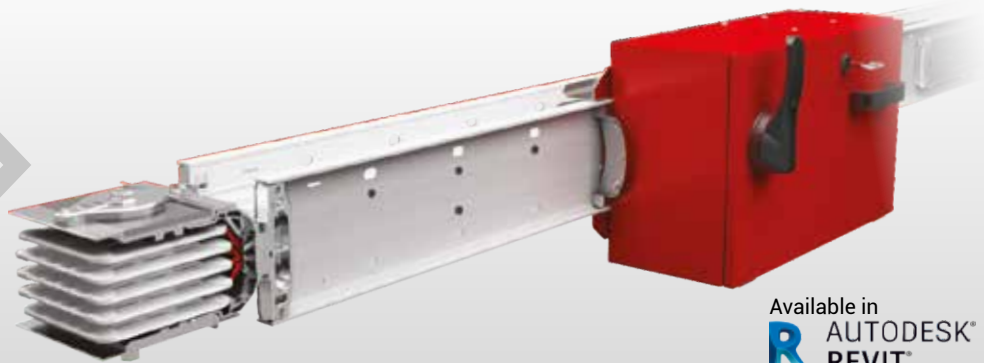

Available in
 AUTODESK®
REVIT™

Fire Certificate

KX Series Busbar

IEC 60331-1 and IEC 60331-21; 1000 °C - 3 Hours
IEC 60331-1; 830 °C - 3 Hours
BS 6387; 950 °C - 3 Hours
BS 8491; 830 °C, 120 minutes + Pressurized Water + Mechanical Impact

Plug-in Tap Off Box

IEC 60331-1; 830 °C - 3 Hours,
Magnetic MCCB
IEC 60331-1; 830 °C - 3 Hours,
NH Circuit Breakers



LV busbar application

Compact Busbar Distribution System 630...6300 A

The body of the E-Line CR busbar is formed using DURACOMP, a composite material of epoxy resin and pure silicon which gives protection against arduous environments and high impact with high conductivity copper and aluminum conductors.

ELINE
CR
BUSBAR

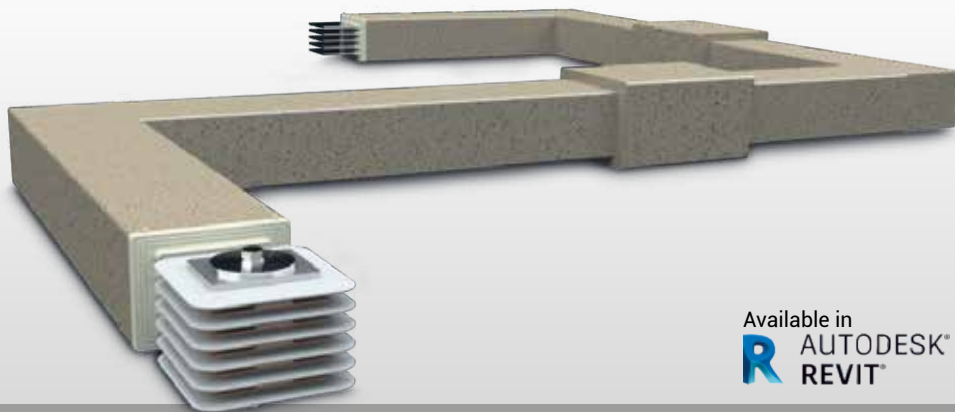

Available in
R AUTODESK®
REVIT™

Fire and Earthquake Resistance

- 3 hours Electrical Continuity under Fire as per IEC 60331-1
- Seismic Resistance as per IEC 60068-3-3 / 60068-2-57 and IEEE 693.

EX - Protected

- ATEX as per EN 60079-0:2009, EN 60079-18:2009, EN60079-31:2009



II 2G Ex mb IIC Gb
II 2D IIIC Db

DIN 4102-12

- System Integrity Under Fire

E60 → Standard
E120 → External Protection Support

IP55
E-LINE KX
400...7500A

IP68
E-LINE CR
630...6300A

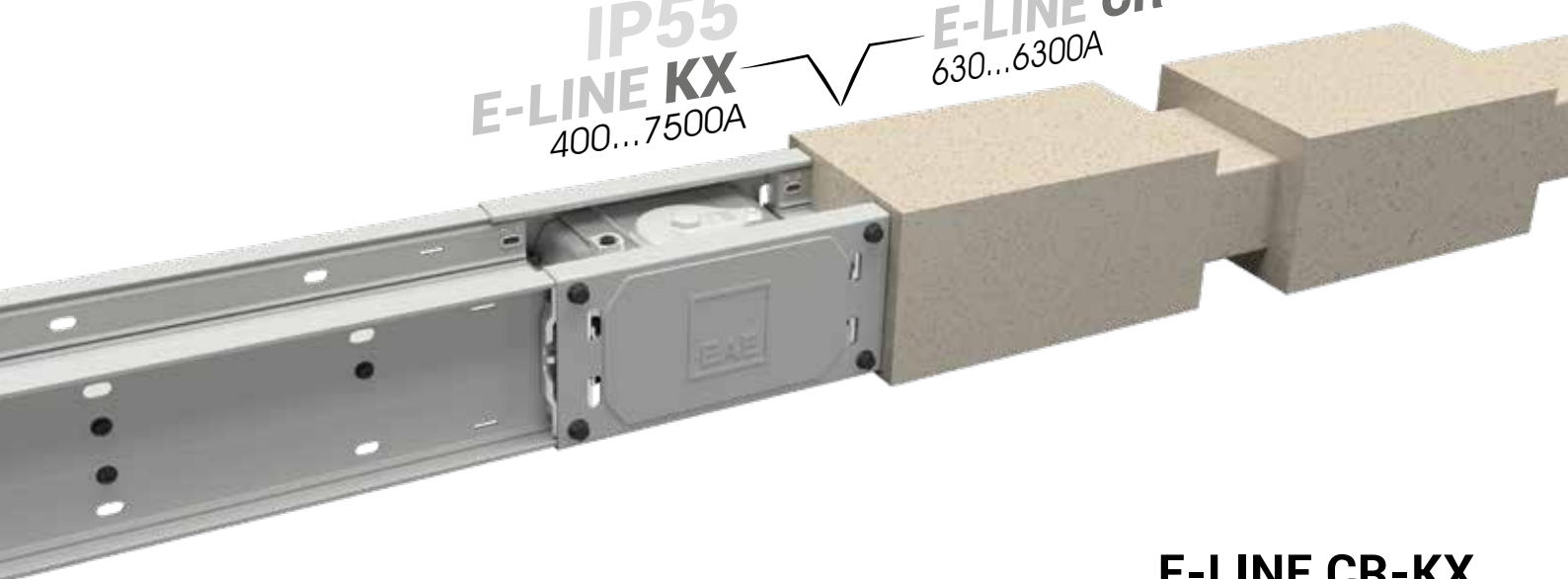

E-LINE CR-KX

Transition Module
CR-KX transition module offers the possibility of reducing time and cost with direct installation.

Hot Dipped Galvanized-Heavy Duty Cable Ladder

The E-Line KMH-KMA ladder with strengthened side rail is designed to carry the cable loads in vertical shafts in indoor or outdoor environments at factories and buildings with their high bearing capacities.

ELINE
KMH
KMA



Features of KMH - KMA

- Length** : Standard in 3000 mm and 6000 mm
- Finishes** : Hot Dip Galvanized (HDG) according to ISO EN 1461 | Deep Galvanised (DG) with Corten A | Stainless Steel 316L (SS304 optional)

Side Rail

- Height** : 040 mm / 050 mm / 060 mm / 075 mm / 100mm / 125mm / 150mm
- Thickness** : 1.0 mm / 1.2 mm / 1.5 mm / 2.0mm / 2.5mm(optional)
- Width** : 100mm to 900mm
- Rung Spacing** : 300mm



Cable ladder application

Extra Heavy Duty Cable Ladder System

KCA OG is designed to satisfy high performance requirements in all industrial applications.

ELINE
**KCA
OG**



Available in
AVEVA
SmartPlant® 3D
INTERGRAPH

Features of KCA OG

- Length** : Standard in 3000 mm and 6000 mm
- Finishes** : Hot Dip Galvanized (HDG) according to ISO EN 1461 | Silicon Rich Steel Sheet (DG) | Stainless Steel 316L (SS304 optional)

Side Rail

- Height** : 100 mm / 125 mm / 150 mm / 200 mm
- Thickness** : 1.5 mm / 2.00 mm / 2.5 mm (optional)
- Width** : Single (100 mm Height) / Double
- Rung Spacing** : (125 mm / 150 mm / 200 mm)

Rung

- Dimension** : 41 (width) x 21 (Height) Strud Channel
- Spacing** : 300 mm
- Width** : 150 mm / 300 mm / 450 mm / 600 mm / 900 mm
- Optional Width** : 200 mm / 750 mm / 1000 mm / 1100 mm
- Thickness** : 1.5 mm / 2.00 mm / 2.50 mm (Optional)

-70°C CERTIFIED



Accordence with
DIN 4102-12 (E90)
Tested at 1000 °C for 90 minutes



20B | 20A | 20C

Aluminum Cable Ladder System

KCA AL is designed to satisfy high performance requirements in all industrial applications.

ELINE
**KCA
AL**



Features of KCA AL

Material: : Extruded Aluminum Alloy 6063-T6
: (Also called Marine Grade Aluminum and Cooper-free Aluminum)

- Excellent And Best Strength-to-weight Ratio
- Can Carry Loads As Much As Steel And Stainless Steel Material
- Can Be Loaded Up To 6-meter Span
- Used In Indoor / Outdoor Service Applications
- Excellent Corrosion-resistance At Marine Environment (where Mostly Corrosive Saline Chlorides Exist)
- Excellent Electrical Conductivity

Dimensional Features

Manufactured dimensions are in Metric Units.

Available in Various Lengths, Heights and Widths:

Length : Standard in 3000 mm / 6000 mm
Width : 150 mm / 200 mm / 300 mm / 400 mm / 450 mm / 500 mm / 600 mm / 750 mm / 900 mm
Side Rail Height : 100 mm / 125 mm / 150 mm / 175 mm (I-BEAM DESIGN)
Loading Depth : 75 mm / 100 mm / 125 mm / 150 mm
Rung Spacing : Standard in 300 mm (Welded) (I-BEAM DESIGN)

Certificates

NEMA VE-1 2017 - Tested and Certified
IEC 61537 / BS EN 61537 / TS EN 61537 - Tested and Certified



20B | 20C

Glassfiber Cable Ladder System

Non-metallic Cable Management System
Pultruded Fiberglass Reinforced Polyester

ELINE
CTA GRP >>>
ELINE
KCA GRP >>>

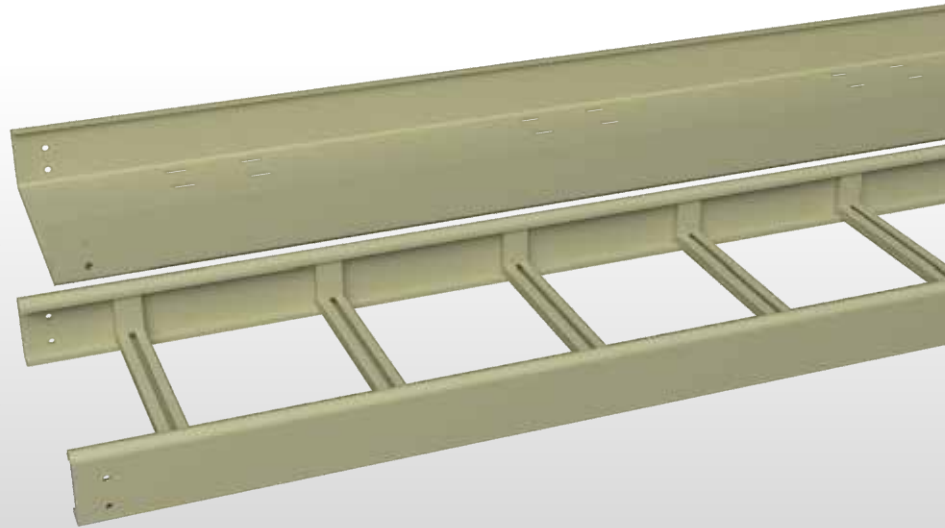

Features of KCA GRP - CTA GRP

Material : UL 94 V-0 / UV resistant/ Halogen-free / ASTM E84 Class-I / non-flame-propagating

- Excellent and Best Strength-to-weight Ratio
- Can Carry Loads as Much As Steel And Stainless Steel Material
- Can Be Loaded Up To 6-meter Span (for cable ladder)
- Can Be Loaded Up To 3-meter Span (for cable tray)
- Used In Indoor / Outdoor Service Applications
- Excellent Corrosion-resistance At Marine Environment (where Mostly Corrosive Saline Chlorides Exist)
- Excellent Electrical Cond

Dimensional Features KCA GRP (Cable Ladder)

Length : 3000 mm / 6000 mm
Width : 150-200-300-400-450-
500-600-750-900 mm
Height : 100 mm (NEMA 12C)
150 mm (NEMA 20C)
Rung Spacing : 300 mm
Radius for fittings : R300/R450/R600

Dimensional Features CTA GRP (Cable Tray)

Length : 3000 mm
Width : 50-100-150-200-250-300
400-450-500-600 mm
Height : 50 mm / 80 mm / 100 mm
Perforation : Perforated / non-perforated

Certificates

Tested and Certified according to:
NEMA VE-1 2017 IEC 61537 / BS EN 61537 / TS EN 61537



Hot Dipped Galvanized-Heavy Duty Cable Ladder

The E-Line CT series hot dip cable trays are used internally or externally in factories and buildings; especially designed to carry heavy duty wiring loads in humid or steamy environments.

ELINE
CT

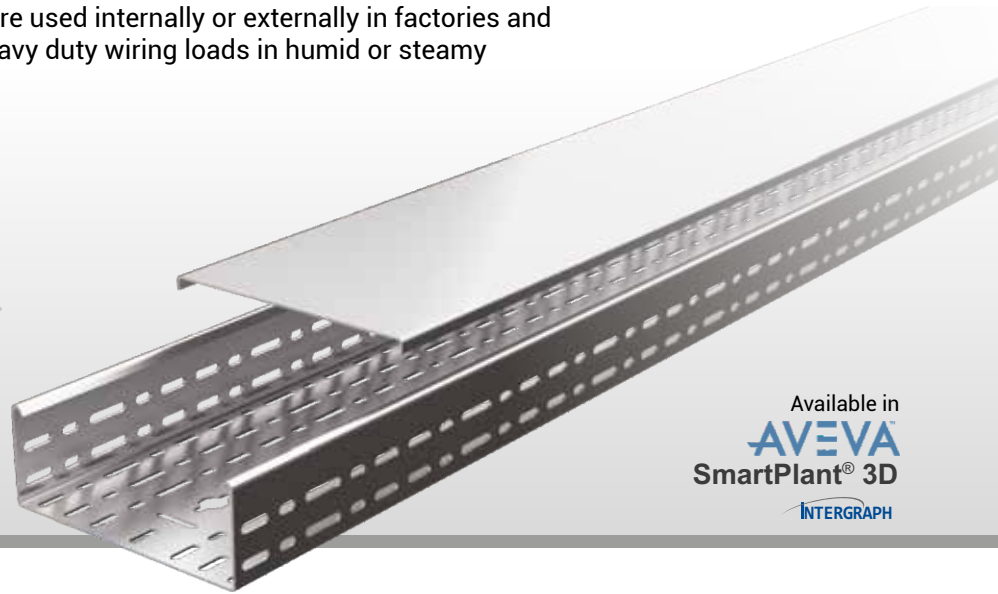

Available in
AVEVA
SmartPlant® 3D
INTERGRAPH

Features of CT Series

- Length** : Standard in 3000 mm and 6000 mm
Finishes : Hot Dip Galvanized (HDG) according to ISO EN 1461 | Deep Galvanised (DG) with Corten A
Stainless Steel 316L (SS304 optional)

Side Rail

- Height** : 040 mm / 050 mm / 060 mm / 075 mm / 100mm / 125mm / 150mm
Thickness : 1.0 mm / 1.2 mm / 1.5 mm / 2.0mm / 2.5mm(optional)
Width : 50mm to 900mm



Cable tray application

Heavy Duty Supporting Systems

E-Line BR and A-A series hot dip galvanized supporting systems are designed for especially heavy duty loading projects.

E LINE
A-A
BR

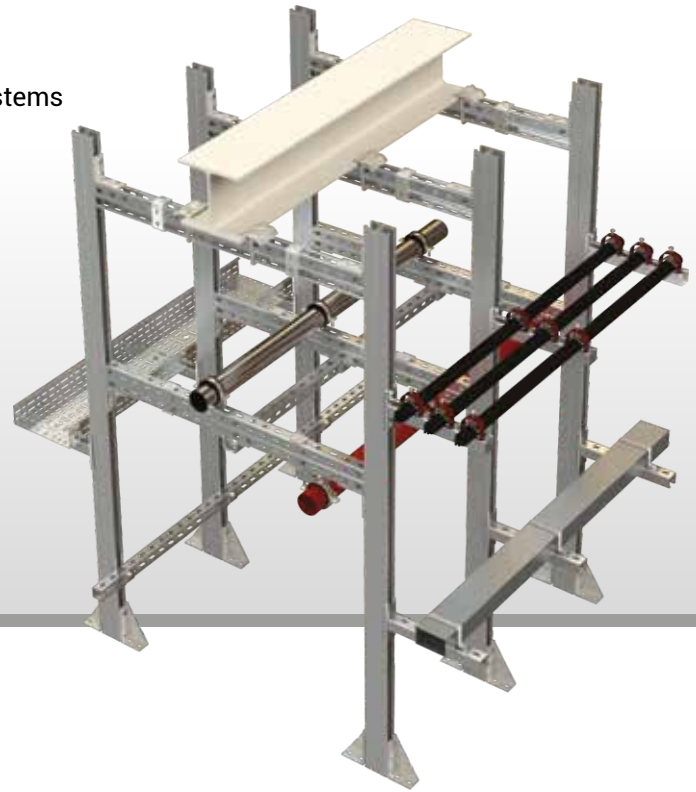

BINRAK DOUBLE CHANNEL (41X82mm)

Hot Dip Galvanized (TS EN ISO 1461) / 304 & 316 Stainless Steel

E-Line BINRAK series of supporting systems are designed for heavy duty loads. The BINRAK series can be produced for 2.0mm and 2.5mm, also pregalvanized or stainless steel.

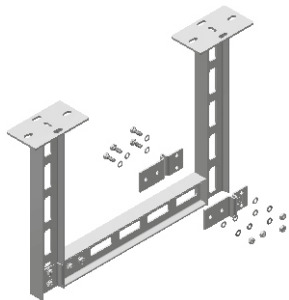

IDD IDY HEAVY SUPPORTS

Hot Dip Galvanized (TS EN ISO 1461)

E-Line cast iron IDD and IDY series of supporting systems are designed for heavy duty loads such as Busbars with NPI80 profile.

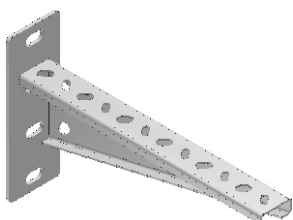

STS-D TRAY SUPPORTS

Hot Dip Galvanized (TS EN ISO 1461)

E-Line STS-D supporting systems are designed to carry heavy duty wall mounted installations.

Industrial Lighting Led Luminaires

Verta product family is the most cost-effective and ideal solution against rapidly rising energy costs. Replacing metal halide and fluorescent lamp luminaires with highly efficient Verta 12K products provides you sufficient lighting with lower energy consumption without sacrificing lighting quality.

VERTA
12K



Road&Street Lighting Luminaires

Arktos fulfils your environmental lighting requirements with minimum energy, maximum comfort and continous performance with numerous advantages provided by LED Technology.

ARKTOS

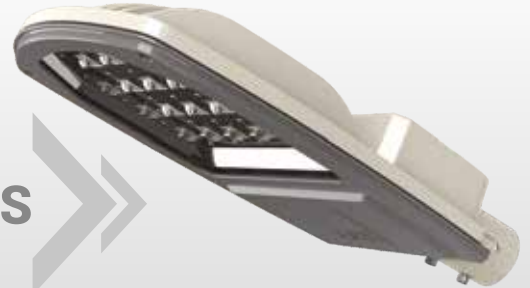

PROLIT III Led Projector

Prolit III is the best fit for projector applications. Extra resilient casing ensures the use of LED technology in rough outdoor conditions.



PROLIT-KOMPAKT Led Projector

Prolit Kompakt is an ergonomic and all-condition LED lighting source with modern and industrial design.



PROLIT II Led Projector

Prolit II is the best fit for projector applications. Extra resilient casing ensures the use of LED technology in rough outdoor conditions.



Certificates







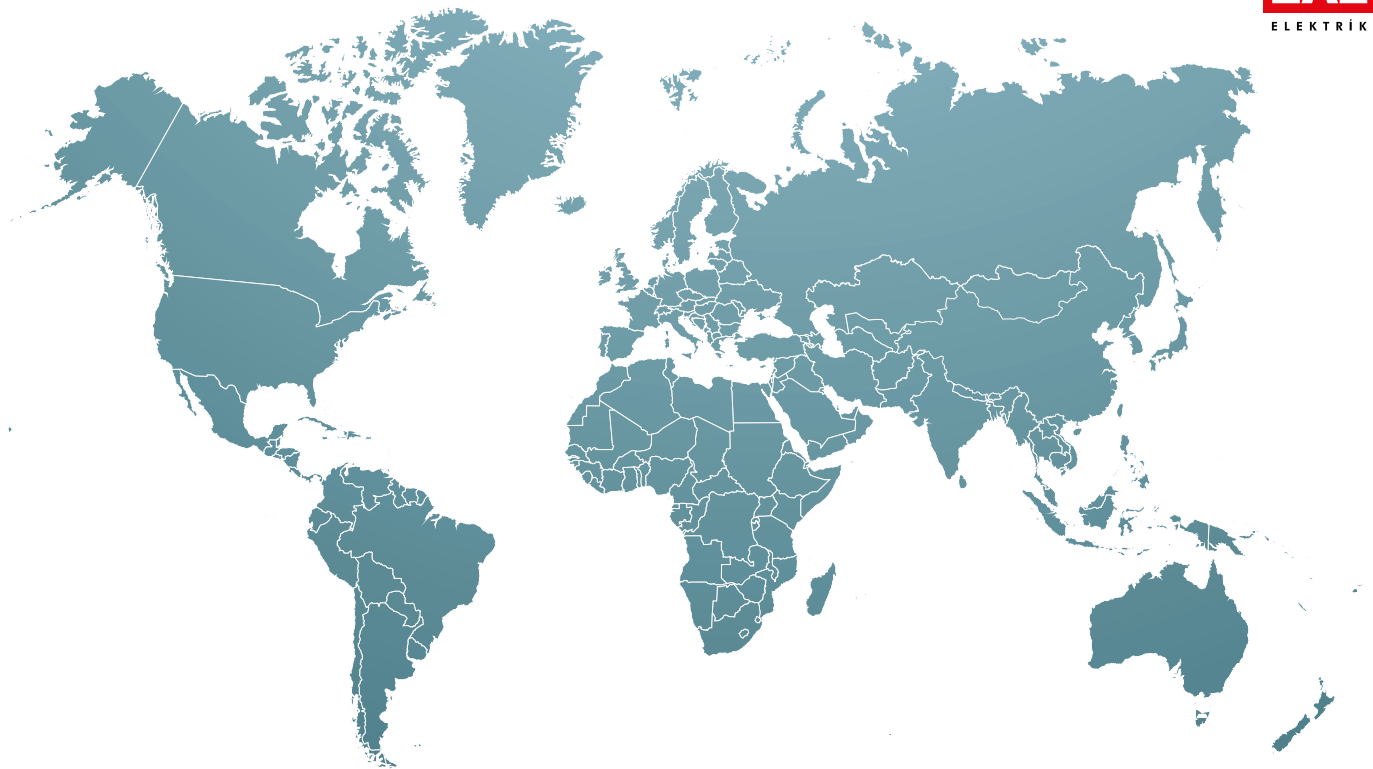

OIL&GAS

References List

- Sonatrach Gas Processing Facility
- Chlor Alkali Chemical Plant
- Socar HDPE
- Waste To Energy Power Plant
- Socar State Oil Company Of Azerbaijan Head Office Building
- Mozyr Refinery
- Mozyr Refinery RTP-13 & 21
- Total Antwerpen
- Lukoil Bourgas Refinery
- Bocamina
- Marine XII Block Off Shore Platform
- Elf Refinerie
- Nainawa Power Plant
- Al Khairat Power Plant
- Erbil Ccpp Power Plant
- Süleymaniye Power Plant
- Bazian Power Plant
- Besmaya Power Plant
- Taq Taq Power Plant
- Taqa Atrush
- Technic
- Ansaldo Aprilia
- Asia Gas Pipeline
- Sicon Oil
- Al Khoms Power Plant
- Bidco Oil
- "Rokita Chemical Plant Brzeg Dolny"
- Lotos
- Raffinaderji Sines
- Tobolsk Polymer LLC
- Shatura Power Plant
- Threshkovo Power Plant
- Kujukhovo Power Plant
- Yamal LNG-CWP3B Plant
- Yayva Power Plant
- Surgutskaya Power Plant
- Ge General Electric Plant
- Sipchem Facility
- Qurayyah Power Plant
- Ras Al Khair Desalination Project
- Tent A Power Plant
- Sloznaft
- Frames Viura
- Pireco
- Power Ship9 Mobile Power Plant
- Aksa Akriklik Power Plant
- Socar Star Aegean Refinery
- 1320MW Karabiga Power Plant
- BTC Pipeline pump Station
- Yunus Emre Power Plant
- Bis Energy Power Plant
- İç Anadolu Power Plant
- Tufanbeyli 450mw Power Plant
- Denizli 775mw Ccpp Power Plant
- Erzin Ccpp Power Plant
- Tupras Aliaga Refinery
- Tupras Aliaga Refinery Pye-815 Turbogenerator Sys
- Tupras Aliaga Distribution Center
- Tupras Aliaga New Headquarters Office Building
- Petkim Aliaga Refinery
- Petkim Aliaga Tubular Project
- Ambarli 300mw Power Plant
- Tupras Kirikkale Hydroprocessing Unit
- Tupras Rup Resid Upgrading Project Izmit
- Tupras Izmit Refinery
- Tupras Izmit Refinery 73 - 74 Unit Gasoline Spec.improvement Project
- Tupras Izmit Refinery 10 R 18 Unit
- Tupras Izmit Refinery Plant 25 - 26
- Tupras Izmit Refinery Plant 36
- Tupras Izmit Refinery Oxygenata Area Substation
- Tupras Izmit Refinery Yt 1250 Plant
- Tupras Izmit Refinery Unrefined Petroleum Tanks
- "Tupras Izmit RefineryPlant 19-21"
- Tupras Izmit Refinery New Social Plant
- Yeni Elektrik Ccpp Power Plant
- Enerjisa Power Plant
- Samsun 870mw Ccpp Power Plant
- Eren 1200mw Power Plant
- Gas Processing Plant Turkmenbashi
- Lotus Energy
- Epic Of Crude Oil Tank Farm Terminal Project
- Onshore Gas Terminal
- Gas to Gasoline Plant
- Mary-3, 1574MW Power Plant
- South Yoloten Gas Field Project
- Mary Fertilizer Complex
- Belleli
- "Al Dhabbiya Gas FacilitiesTR Station"
- "Al Rumeitha Gas Facilities TR Station"
- Abu Dhabi Petrochemical Refinery
- Shah Gas Development Project
- Adnoc Abu Dhabi National Oil C. Head Office Building
- District Cooling Plant RB02 / Rb03
- District Cooling Plant – T07
- District Cooling Plant Al Raha Beach
- District Cooling Plant Jabel Ali
- "District Cooling PlantRC-1/RC-2 / LC-2 Jabel Ali"
- Emicool District Cooling Plant
- Mobil Oil Petrochemical Plant
- Carrington Power Plant
- Rabab Harweel Integrated Project
- Yibal Khuff Projct
- Salalah LPG Project
- Birba Project

Component List		
Item No	Component	Quantity

Company : _____
 Project : _____
 Project No: _____

Prepared by : _____
 Name : _____
 Date : _____
 Signature : _____

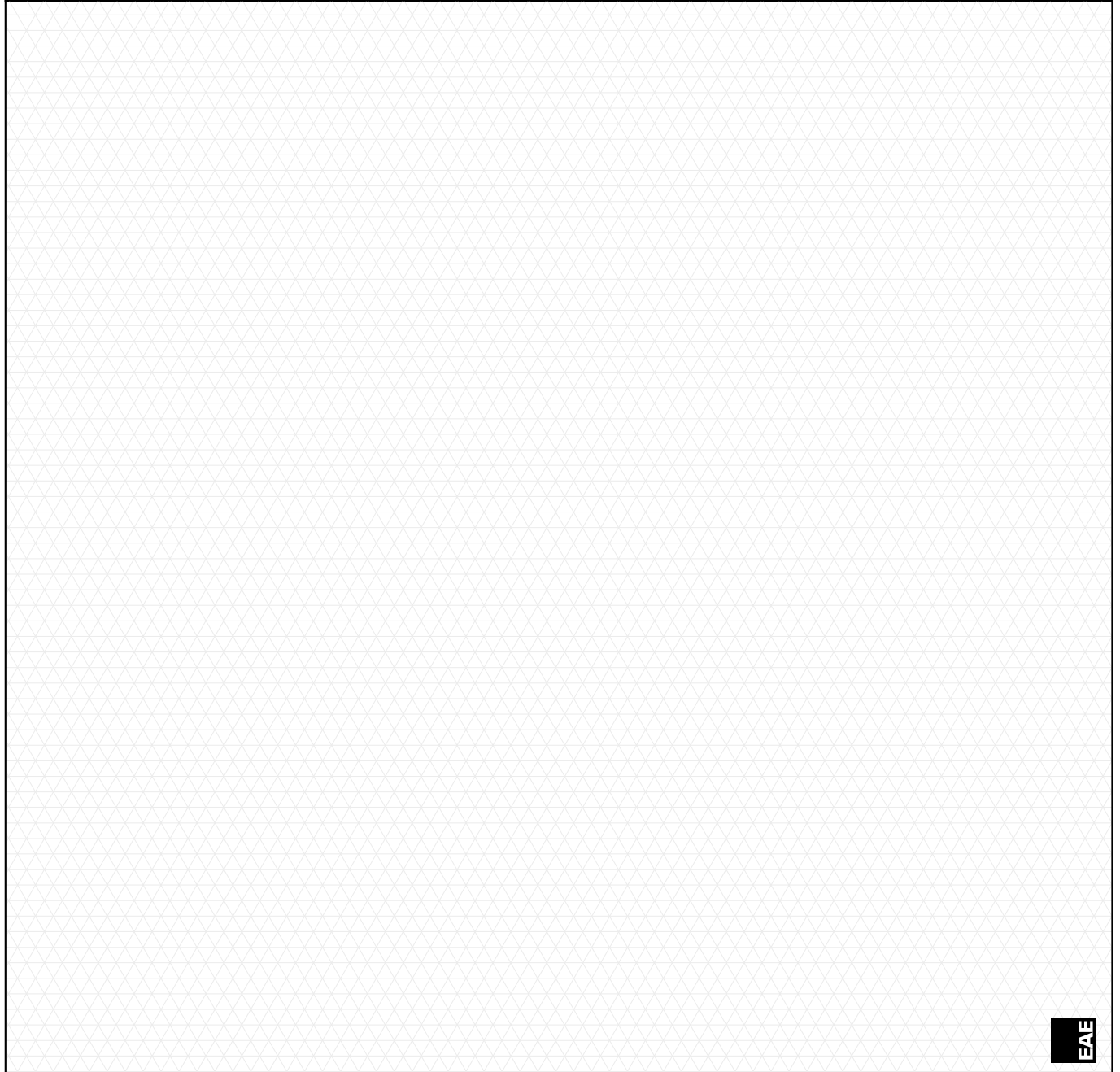

Please duplicate this page for your own use.

PRODUCT TYPES



BUSBAR ENERGY DISTRIBUTION SYSTEMS



CABLE TRAYS



TROLLEY BUSBAR ENERGY DISTRIBUTION SYSTEMS



INDOOR SOLUTIONS



SUPPORT SYSTEMS

Please visit our website for the updated version of our catalogues.
www.eaeelectric.com



EAE Elektrik A.S.
Head Office
Akcaburgaz Mahallesi,
3114. Sokak, No:10 34522
Esenyurt - Istanbul - TURKEY
Tel: +90 (212) 866 20 00
Fax: +90 (212) 886 24 20

EAE DL 3 Factory
Busbar
Makine Ihtisas Organize Sanayi
Bolgesi Mahallesi, 6. Cadde,
8. Sokak, No:6 41455
Dilovası - Kocaeli - TURKEY
Tel: +90 (262) 502 05 65
Fax: +90 (262) 502 05 70

Please visit our website for the updated version of our catalogues.
www.eaelectric.com



IEC 61439-6



Catalog 15-En. / Rev 12 500 Ad. 20/08/2021
S.S.

EAE has full right to make any revisions or changes on this catalogue without any prior notice.

